

# Kippenhok Nelly

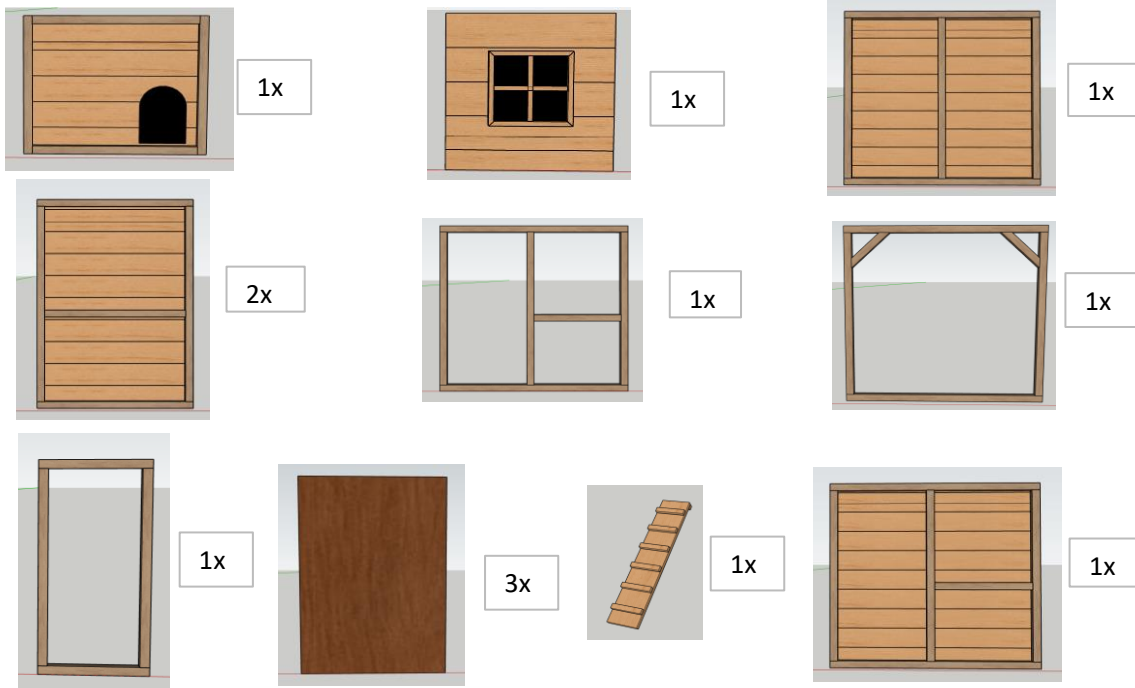

## Benodigheden:

- Schroefmachine
- Rolmaat
- Bit pz2
- Bit pz1
- Boortje 4mm (is meegeleverd)
- \*ALLE SCHROEVEN VOORBOREN\***



**Dakbedekking**  
-1x 240x95cm



**\*Spie\***  
-4x 85cm



### Lat

- 2x 71,4cm (30x16mm)
- 2x 34cm (65x16mm)
- 2x daktrim 121,5cm
- 2x daktrim 95cm

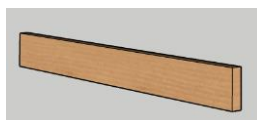

### Balk 44x44mm

- 1x 79cm
- 2x 120cm
- 1x 57cm



### Overige

- 1x Konijntoilet
- 4x Geheng 20cm
- 2x schuifslot

- 38x Schroef 70mm
- 24x Schroef 40mm
- 60x Schroef 30mm
- 20x Schroef 20mm

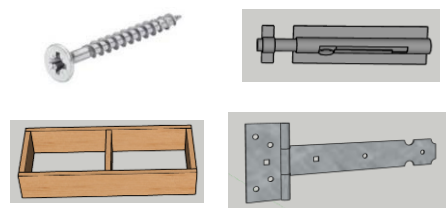

**1.**

2x Lat 30x16mm - 2x 71,4cm  
6x Schroef 30mm

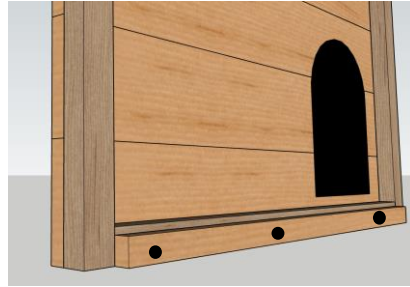
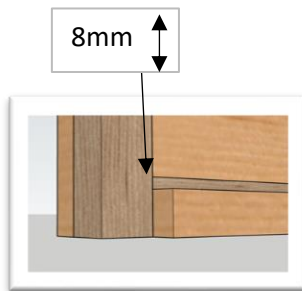

**2.**

3x Schroef 70mm



Onder/bovenaanzicht

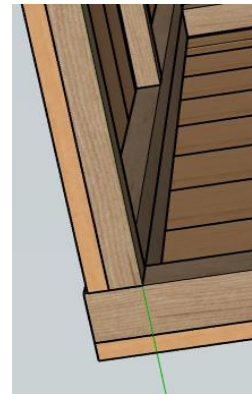

**3.**

3x Schroef 70mm



**4.**

**3x Schroef 70mm**

Onder/bovenaanzicht

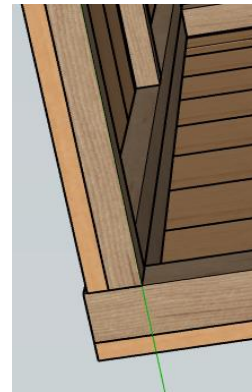

**5.**

**3x Schroef 70mm**

Onder/bovenaanzicht

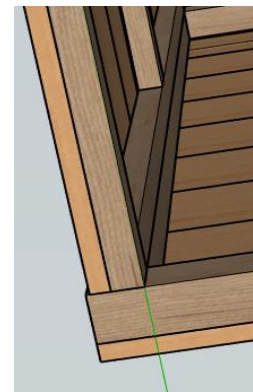
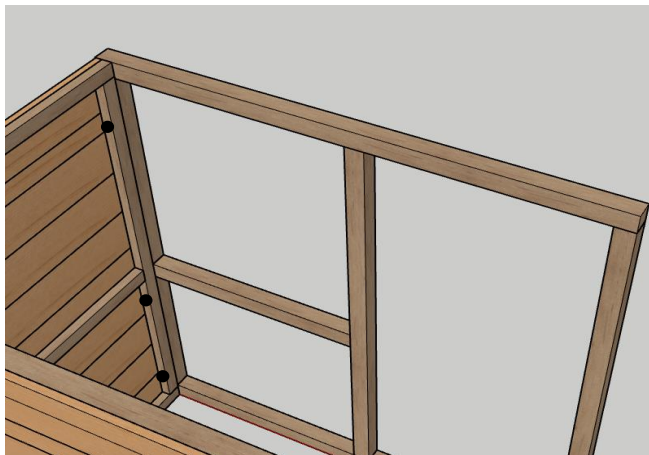

**6.**

**4x Schroef 70mm**

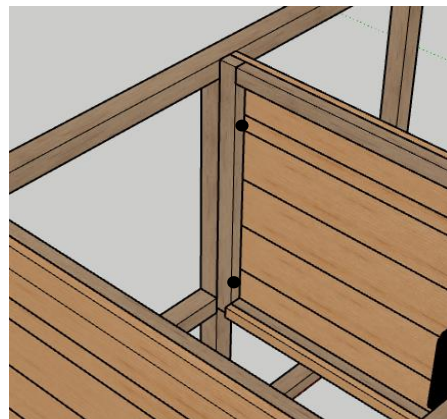
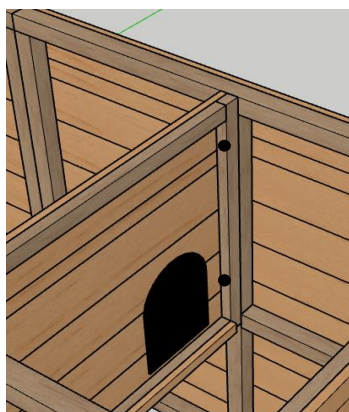

**7.**

**6x Schroef 70mm**

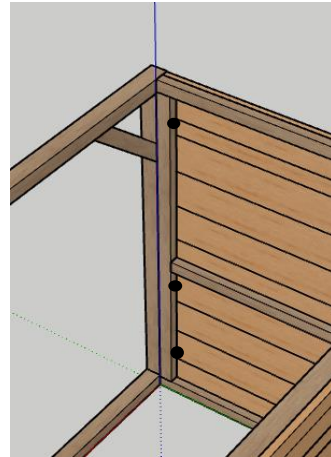

**8.**

**1x betonplex 55x85cm**

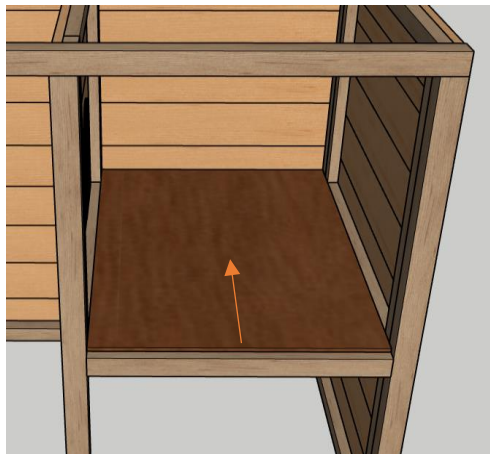

**9.**

**1x Balk 44x44mm - 79cm  
4x Schroef 70mm**

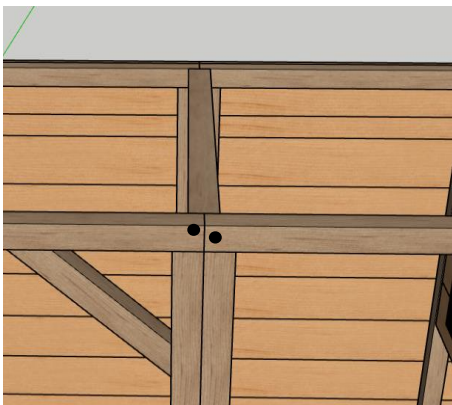

**10.**

2x Balk 44x44mm - 120cm  
6x Schroef 70mm

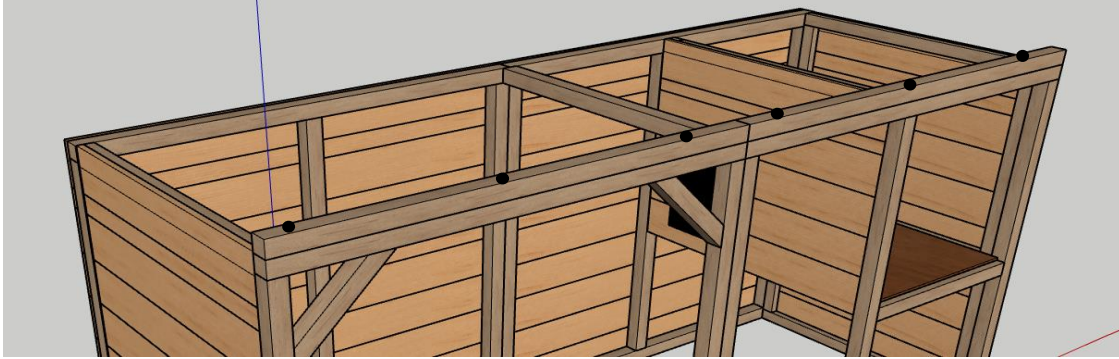

**11.**

4x \*spie\* 85cm  
4x Schroef 70mm  
4x Schroef 40mm

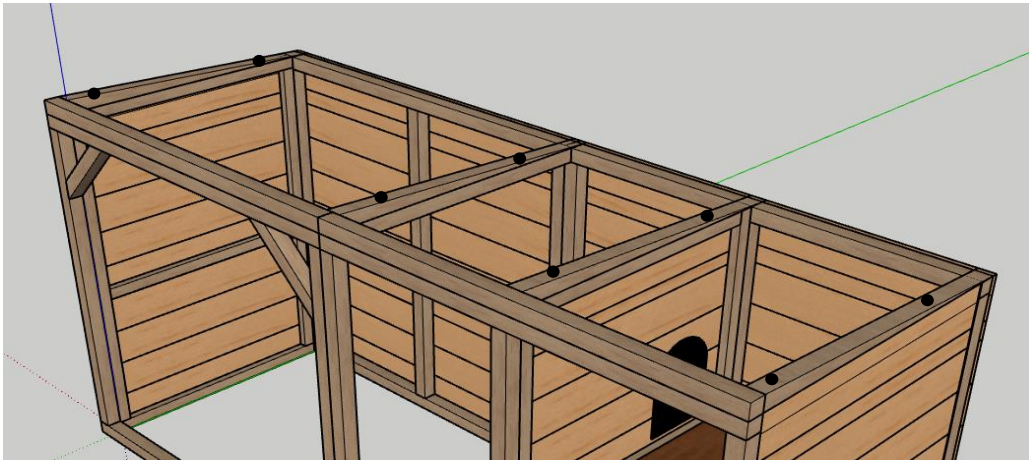

**12.**

4x geheng 20cm  
12x Schroef 30mm

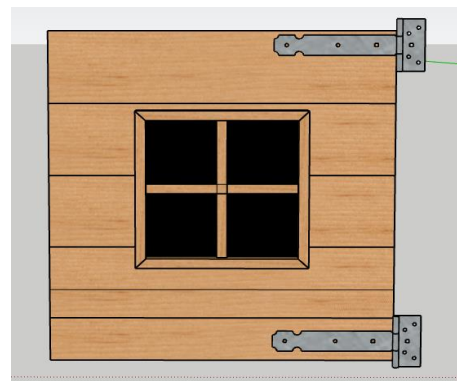
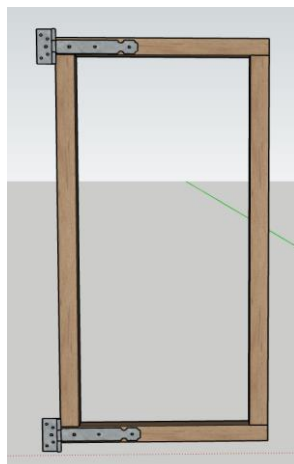

**13.**

2x Schuifslot  
8x Schroef 40mm  
16x Schroef 20mm

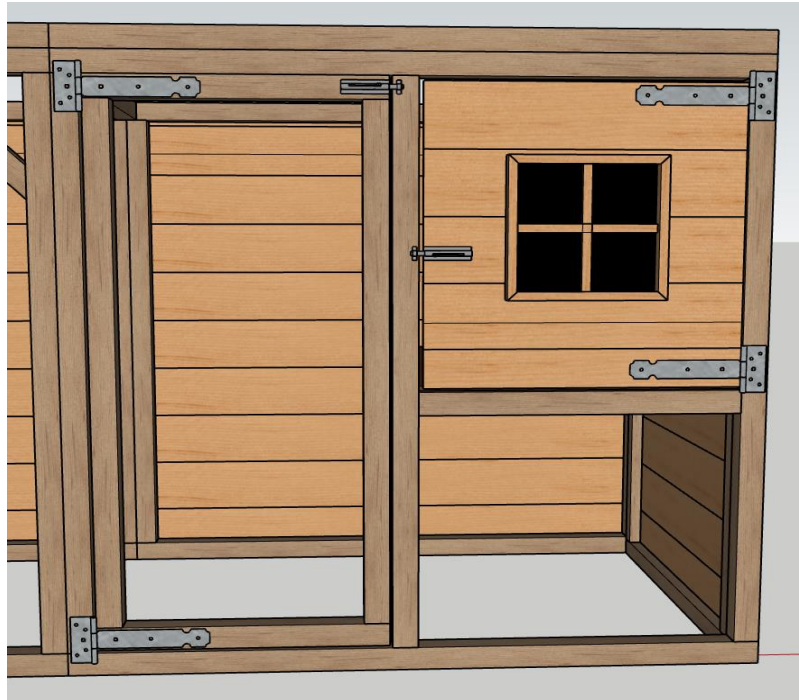

**14.**

2x betonplex 117,8x91,8cm  
14x Schroef 30mm

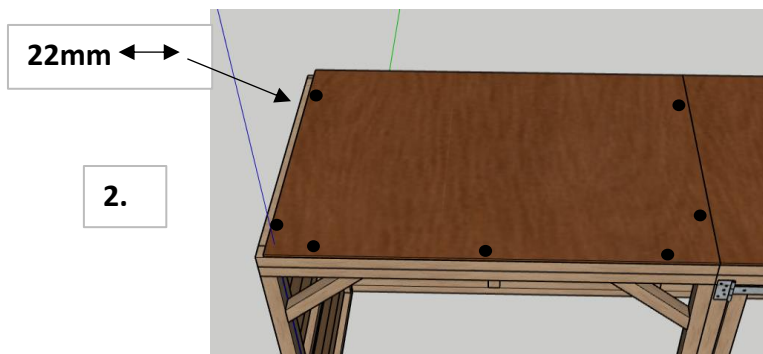
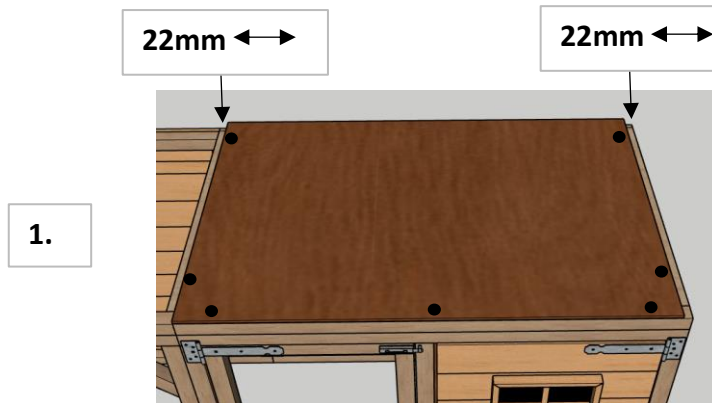

**15.**

1x dakbedekking 240x95cm



**1.**  
Verdeel de dakbedekking over de betonplex platen. Zorg dat de smalle strook folie aan de boven en voorzijde zit. Verwijder hierna de folie.



**2.**  
Verwijder de folie van de onderzijde en verdeel hierna de dakbedekking over de betonplex platen.

- Voorzijde gelijk
- Linker + rechterkopzijde gelijke overstek
- Achterzijde steekt door.



**16.**

2x Daktrim 95cm  
2x Daktrim 121,5cm  
16x Schroef 30mm

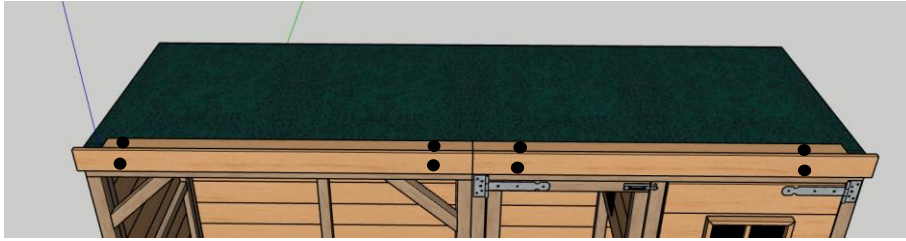

1.



2.

**17.**

2x Lat 65x16mm -34cm  
1x Balk 44x44mm - 57cm  
1x Legbak  
12x Schroef 30mm

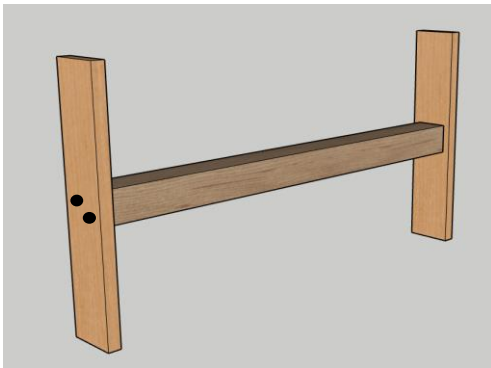

1.



2.



# Legnest

1.

Verwijder twee planken aan de kopzijde

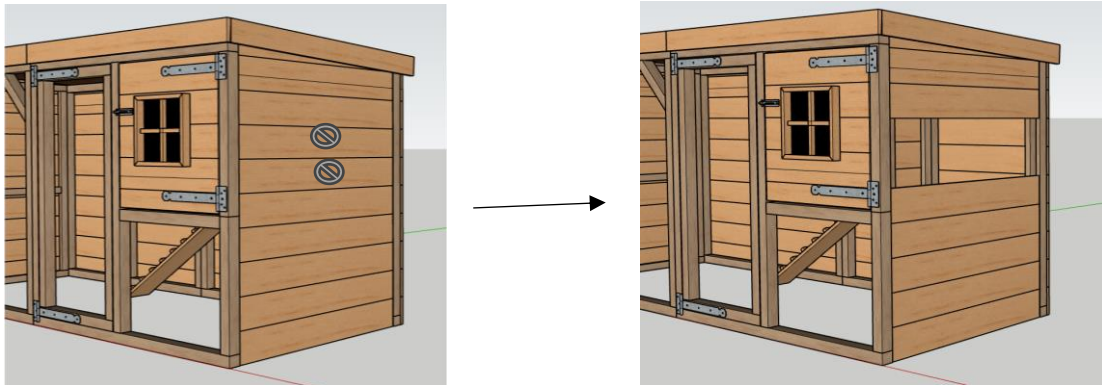

2.

4x schroef 60mm

